

COMPARTMENT SIZE	3	4	5	6	7	8	9	10	11	12	13	14	15	16
DIMENSION (CLEAR)	1 $\frac{7}{8}$ "	2 $\frac{11}{16}$ "	3 $\frac{1}{2}$ "	4 $\frac{1}{4}$ "	5 $\frac{1}{16}$ "	5 $\frac{7}{8}$ "	6 $\frac{11}{16}$ "	7 $\frac{1}{2}$ "	8 $\frac{1}{4}$ "	9 $\frac{1}{16}$ "	9 $\frac{7}{8}$ "	10 $\frac{11}{16}$ "	11 $\frac{1}{2}$ "	12 $\frac{1}{4}$ "

**PART NUMBER OPTIONS:**

- S40303010100L** = SINGLE DRAWER ACCESS / NO LAYOUTS
- S40303010101L** = SINGLE DRAWER ACCESS / LAYOUTS FACTORY INSTALLED
- M40303010100L** = MULTIPLE DRAWER ACCESS / NO LAYOUTS
- M40303010101L** = MULTIPLE DRAWER ACCESS / LAYOUTS FACTORY INSTALLED
- N40303010100N** = NO LOCKING SYSTEM / NO LAYOUTS
- N40303010101N** = NO LOCKING SYSTEM / LAYOUTS FACTORY INSTALLED

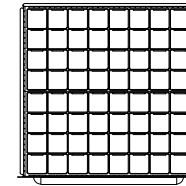

**DRAWER LAYOUT "AA"**  
64 PLASTIC BINS

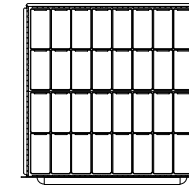

**DRAWER LAYOUT "BB"**  
32 PLASTIC BINS

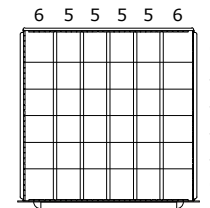

**DRAWER LAYOUT "0H"**  
36 COMPARTMENTS

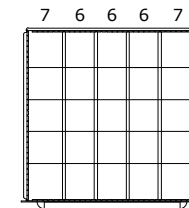

**DRAWER LAYOUT "0G"**  
25 COMPARTMENTS

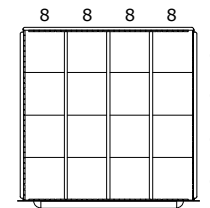

**DRAWER LAYOUT "0P"**  
16 COMPARTMENTS

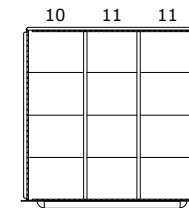

**DRAWER LAYOUT "0L"**  
12 COMPARTMENTS

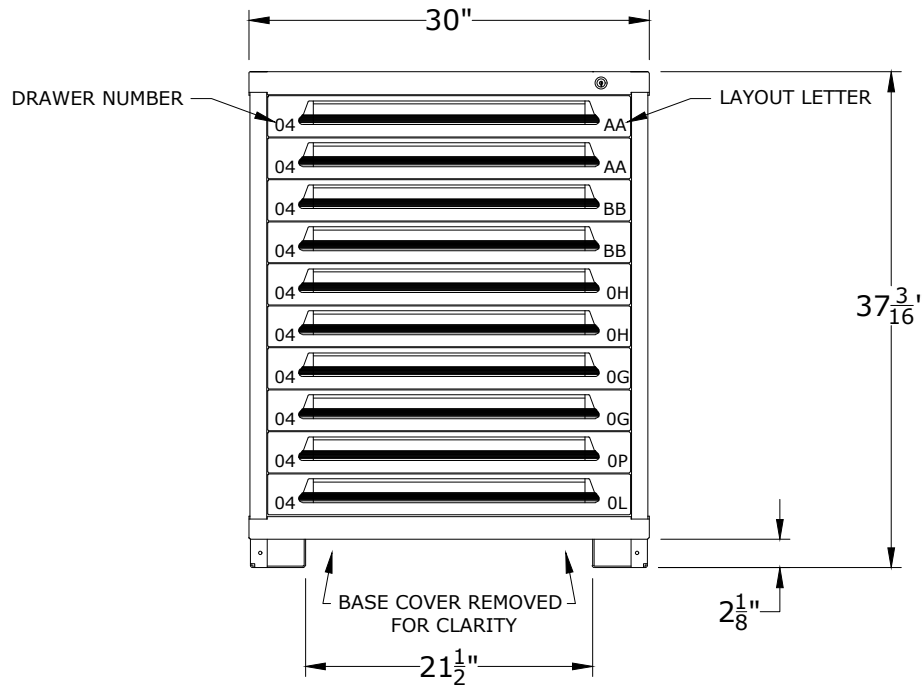

CABINET DEPTH @ 28-1/4" w/  
FULL EXTENSION, 450Lb. CAPACITY DRAWERS  
EACH @ 25-1/8"W x 25-1/8"D USABLE

\*OTHER LOCK OPTIONS AVAILABLE, CONTACT FOR DETAILS

DRAWER NUMBER	04	05	06	07	08	09	10	11	12	13	14	15	16	17	18
USABLE HEIGHT	2 $\frac{1}{4}$ "	3"	3 $\frac{7}{8}$ "	4 $\frac{5}{8}$ "	5 $\frac{3}{8}$ "	6 $\frac{1}{4}$ "	7"	7 $\frac{3}{4}$ "	8 $\frac{1}{2}$ "	9 $\frac{3}{8}$ "	10 $\frac{1}{8}$ "	10 $\frac{7}{8}$ "	11 $\frac{3}{4}$ "	12 $\frac{1}{2}$ "	13 $\frac{1}{4}$ "

**LYON** P.O. Box 671  
AURORA, IL 60507-0671  
PHONE: 800-323-0082  
www.lyonworkspace.com

NOTICE: THIS DOCUMENT IS CONFIDENTIAL AND PROPRIETARY. NO PART OF THIS DOCUMENT MAY BE DISCLOSED TO A THIRD PARTY WITHOUT THE PRIOR WRITTEN CONSENT OF LYON LLC

DATE 06-26-17	DRAWN BY JR	CHECKED BY DWV
------------------	----------------	-------------------

DESCRIPTION  
**PRE-ENGINEERED CABINET  
MID RANGE - STANDARD  
(10) DRAWERS  
(342) COMPARTMENTS**

SHEET	DRAWING NUMBER 4030301010	REV 1
-------	------------------------------	----------